

E-06, E-19 AND E-50

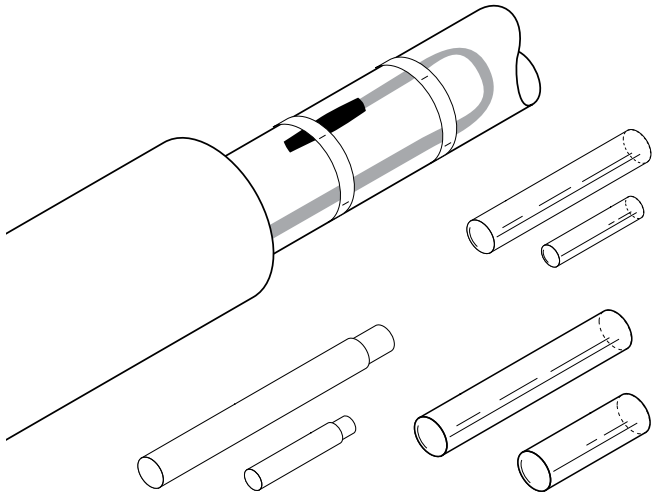

RAYCHEM

HEAT-SHRINK UNDER INSULATION END SEAL KITS



These end seal kits are designed for the termination of nVent RAYCHEM'S industrial heating cables.

The nVent RAYCHEM E-06 is designed for use with BTV- and QTVR heating cables, the nVent RAYCHEM E-19 is designed for use with XTV- and KTV heating cables, and the nVent RAYCHEM E-50 is for use with VPL heating cables. All kits are approved for use in hazardous areas.

The end seal kits E-06 and E-19 employ easy to use heat-shrinkable tubing with an adhesive, that when heated forms a semi-flexible moisture proof encapsulation. The end seal kit E-50 employs high temperature heat-shrinkable tubing with a plastic melt liner that when heated forms a semi-flexible moisture proof encapsulation. Due to the low profile design the finished termination can be installed directly on the pipe.

One end seal kit is required for each termination.

APPLICATION

E-06	E-19	E-50
End seal for BTV and QTVR self-regulating heating cables	End seal for XTV and KTV self-regulating heating cables	End seal for VPL power-limiting heating cables

KIT CONTENTS

Heat-shrinkable Adhesive coated sleeves Installation instruction	Heat-shrinkable sleeves Adhesive liners Installation instruction	Heat-shrinkable sleeves Installation instruction
--	--	---

APPROVALS

ATEX certified by Baseefa and PTB

 II 2 GD Ex e II

Ex tD A21 IP66

The temperature class depends on the design and the type of heating cable the end seal is used with

DNV Certificate No. DNV-GL TAE00000TU (E-06)

DNV Certificate No. DNV-GL TAE00000TV (E-19)



TC RU C-BE.MIO62.B.00054/18

ООО "ТехИмпорт"

PRODUCT SPECIFICATIONS

	E-06	E-19	E-50
Max. exposure temperature	175°C	200°C	260°C
Dielectric strength	2.2 MV/m	> 6 MV/m	> 40 MV/m
Volume resistivity	10 ¹³ Ω cm	10 ¹⁰ Ω cm	10 ¹⁸ Ω cm
Final dimensions	length approx. 120 mm	length approx. 135 mm	length approx. 120 mm

INSTALLATION DETAILS

Heat shrinkable tubing	175 °C	200 °C	327 °C
Gas torch or equivalent	min. 1460 W hot air gun	min. 1460 W hot air gun	min. 3000 W hot air gun*

ORDERING INFORMATION

Part description	E-06	E-19	E-50
PN (Weight)	582616-000 (0.03 kg)	090349-000 (0.05 kg)	1244-002492 (0.06 kg)

*The installation of the E-50 requires a high power heat gun and an experienced installer.

North America

Tel +1.800.545.6258
Fax +1.800.527.5703
thermal.info@nvent.com

Europe, Middle East, Africa

Tel +32.16.213.511
Fax +32.16.213.604
thermal.info@nvent.com

Asia Pacific

Tel +86.21.2412.1688
Fax +86.21.5426.3167
cn.thermal.info@nvent.com

Latin America

Tel +1.713.868.4800
Fax +1.713.868.2333
thermal.info@nvent.com



nVent.com

Our powerful portfolio of brands:

CADDY ERICO HOFFMAN RAYCHEM SCHROFF TRACER