

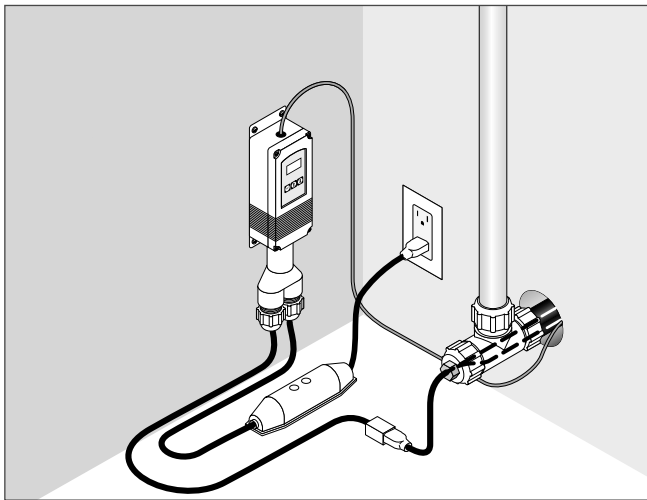

## RAYCHEM

# In-Pipe Retro – 120 V

## In-Pipe Freeze Protection Heating Cable Installation Instructions



### APPROVALS



Note: This product is suitable for use in potable water.

-PS,X/D  
Made in Canada

### KIT CONTENTS

Item	Qty	Description
A	1	Ground-fault protected temperature controller with 25 ft (7.6 m) sensor lead wire
B	2	1-1/4 inch pipe adaptor parts
C	2	1 inch pipe adaptor parts
D	1	Nut for plastic tee fitting
E	1	Plug-in heating cable with plastic tee fitting
F	1	Installation instructions (English and French)

### DESCRIPTION

nVent RAYCHEM In-Pipe Retro is a high wattage in-pipe heating cable designed for freeze protection of uninsulated plastic potable water lines. It is made with a tough mineral insulated cable for long life and has a cord and plug for ease of installation. The kit includes a ground-fault protected electronic temperature controller. The ground-fault protection ensures compliance with nVent, NEC and CEC requirements for ground-fault protection of equipment. It does not protect people against the hazards of shock. For use with either 1 inch or 1-1/4 inch plastic pipe. **Please leave these instructions with the homeowner.**

**Note: The blue tee fitting supplied with this heating cable is designed for use with 1 inch or 1-1/4 inch ID polyethylene pipes and only for the pipe types shown below.**

I.D. Series 75 & 100 (PE 1404) (SIDR 9)

I.D. Series 125 (PE 2306, 2406 or 3406 resin) (SIDR 11.5)

I.D. Series 160 (PE 3408 resin) (SIDR 9)

### TOOLS REQUIRED

- Screwdriver
- Rubber mallet
- Approximately 6 ft (2 m) of strong string or cord
- Pipe wrench to tighten nuts on tee fitting
- Electrician's fish tape

### ADDITIONAL MATERIALS REQUIRED

- (4) #8 mounting screws, for temperature controller
- Duct tape to attach temperature sensor and sensor lead wire to pipe
- Wooden block

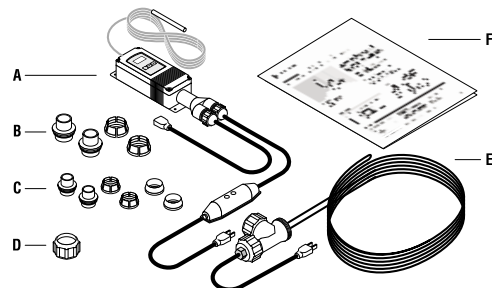

### WARNING:

**FIRE AND SHOCK HAZARD.** In-Pipe Retro must be installed correctly using the supplied temperature controller to ensure proper operation and to prevent shock, fire or damage to the pipe. Read these important warnings and carefully follow all the installation instructions.

- In-Pipe Retro must not be used in insulated pipes. For insulated pipes use nVent RAYCHEM In-Pipe Miser.
- The heating cable must be installed in accordance with local and national electrical codes.
- Do not use a two-prong outlet, an extension cord, or with any voltage other than 120 Vac.
- The ground-fault protected temperature controller must be installed in a dry location. Press the test button, then reset button, every month to assure proper operation.
- Do not unduly work or bend the cable (minimum inside bend radius is 6 times the outside diameter of the heating cable). Bend gently and avoid repeated sharp bends, pinching, crimping, or flattening.
- Do not cut or alter the heating cable or power cord length.
- The heating cable must not pass through a pitless adaptor, valve or shut off of any kind.
- Do not install this heating cable on the outside of piping.
- Do not energize the system until installation is complete and the pipe is filled with water. Never energize the system if the pipe is not filled with water.
- The temperature sensor must contact the pipe at all times or it could sense an incorrect temperature.

1

**Note:** The minimum installation temperature for this in-pipe heating kit is 32°F (0°C).

- **Disconnect any existing electrical connections and open up access to both ends of the pipe.** The existing pipe must run far enough out into the lake or river to get below the ice level or down into the well to get below the frost line. The pipe should be at least 1 ft (30 cm) longer than the heating cable. Cut the end of the pipe square and deburr.

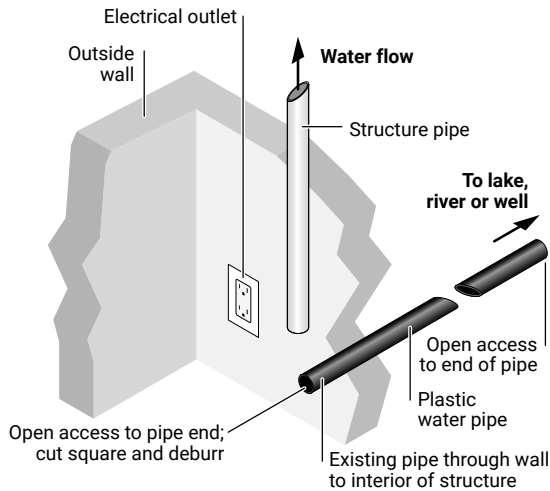

2

**For 1 inch pipe:**

- Place nut, nut reducer, and small flange on pipe in the order and direction shown.

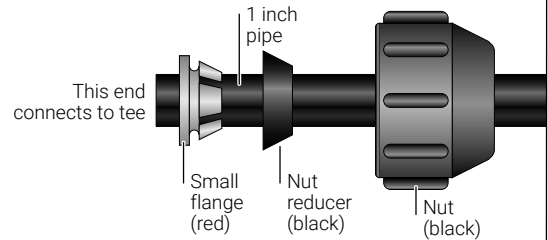

**For 1-1/4 inch pipe:**

- Place nut and large flange on pipe in the order and direction shown (the nut reducer is not required).

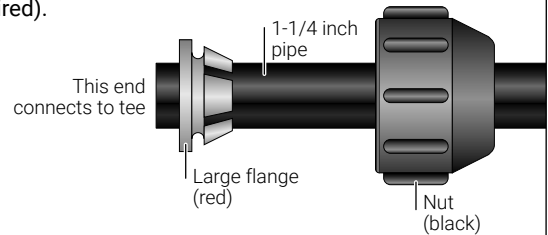

3

- Tap pipe insert into pipe (1-1/4 inch pipe shown), preferably with a flat object, such as a block of wood, to avoid damaging the plastic insert.

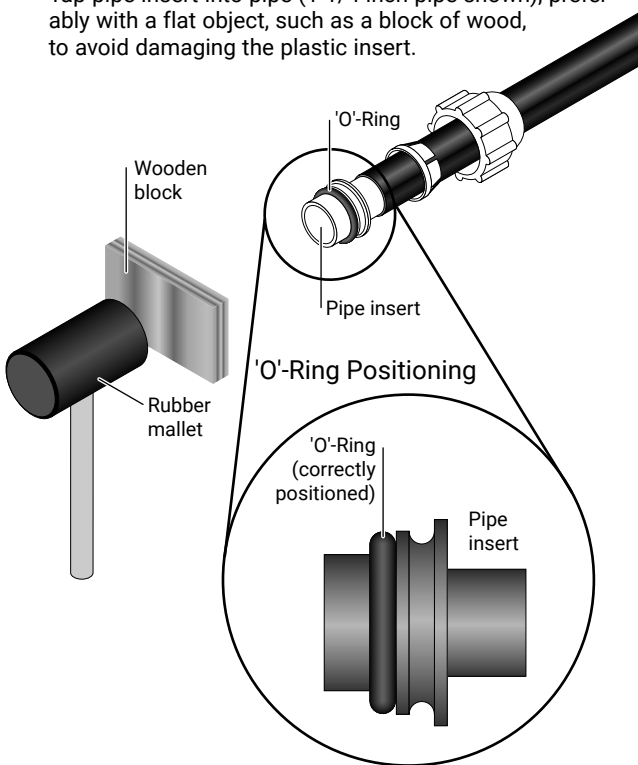

4

- Use an electrician's fish tape (available from rental supply stores) to pull the heating cable into the pipe. Starting at the end **away** from the power supply end, feed the electrician's fish tape back through the pipe (1-1/4 inch pipe shown). Using strong string or cord, tie the end of the fish tape to the loop on the heating cable so that the end of the fish tape is separated by about 2 ft (60 cm) from the loop on the heating cable. Locate the knot at the fish tape end.

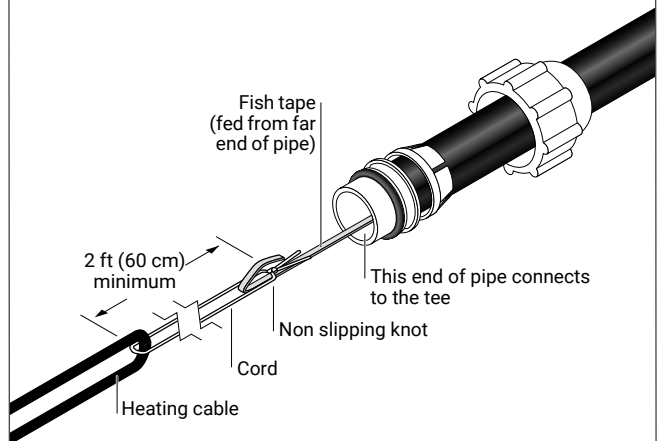

5

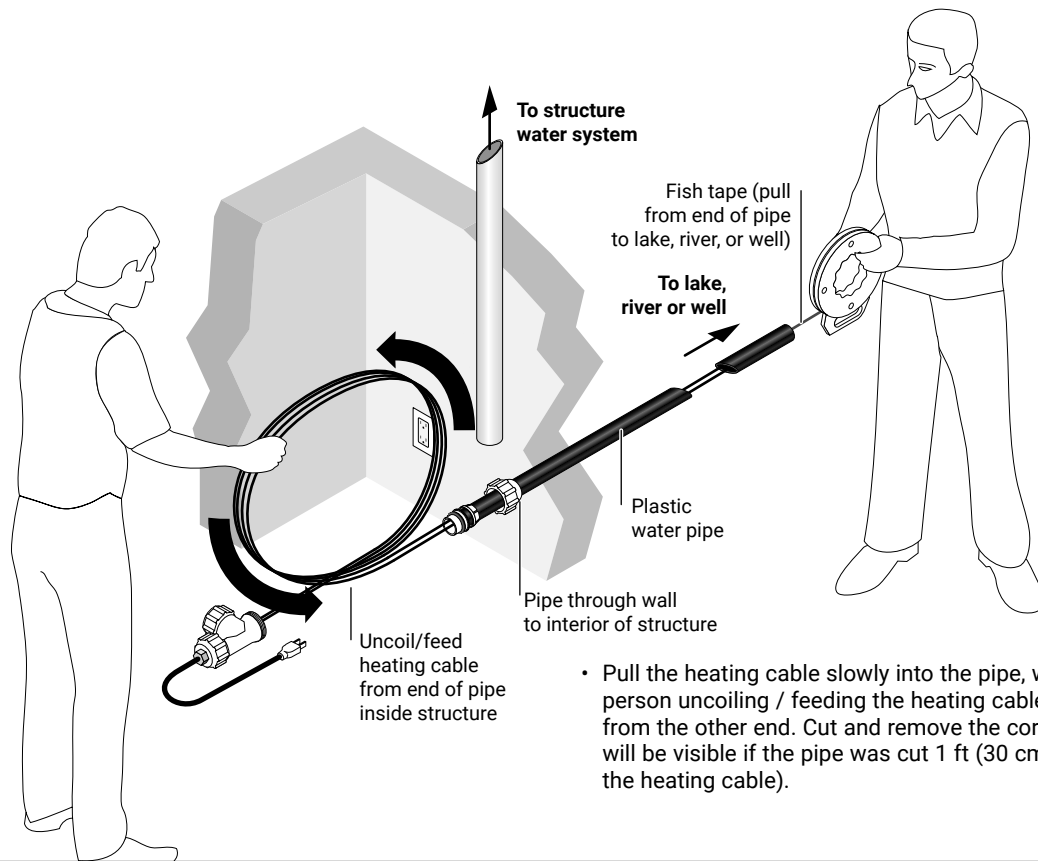

- Pull the heating cable slowly into the pipe, with a second person uncoiling / feeding the heating cable into the pipe from the other end. Cut and remove the cord (the cord will be visible if the pipe was cut 1 ft (30 cm) longer than the heating cable).

6

- Ensure that the 'O'-ring seal is correctly positioned on the pipe insert (see Step 3). Push the tee onto the insert/O-ring seal assembly. Slide the red flange (and nut reducer if using 1" pipe) up to the insert shoulder and tighten the nut using a wrench.

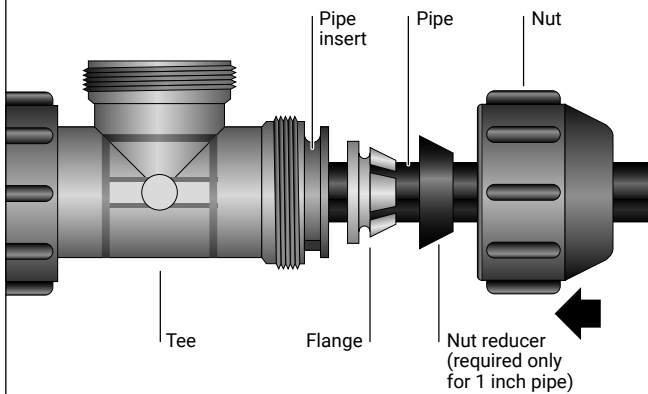

7

- Attach the vertical segment of the blue tee to structure water system in a similar manner (Steps 2, 3 and 6).

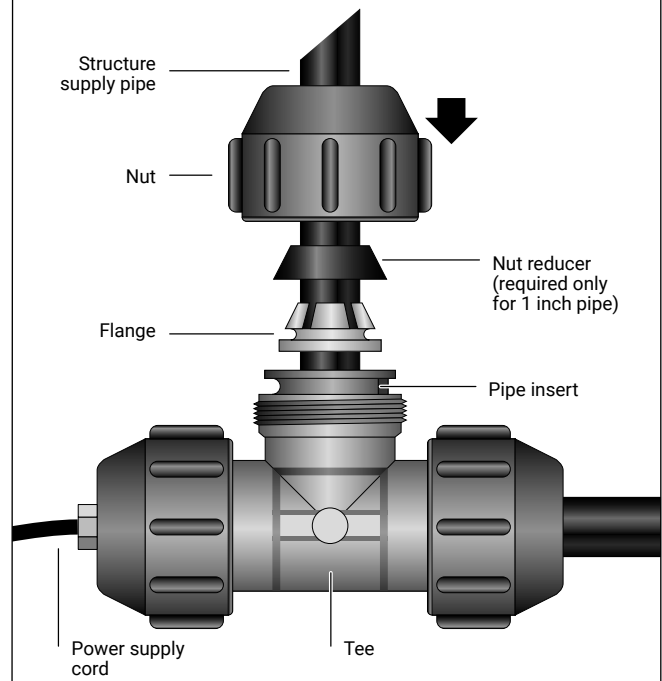

8

- Reconnect the submersible pump or foot valve to the lake/river/well water supply end, if not already connected (the pump/foot valve would have been removed to allow installation of the heating cable). **The submersible pump or foot valve will ensure that the pipe is full of water at all times.**

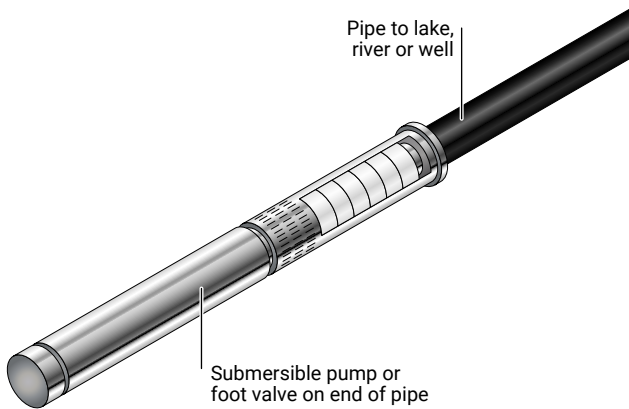

9

- Check that the brass nut and the black nut where the flexible cord exits the tee are tightened securely (60 to 70 inch-lbs torque). Do not over tighten brass nut as this may damage the internal 'O'-ring seal. Test the system at normal water pressure to check that it is leak free. **Do not plug the power cord into the electrical outlet.**

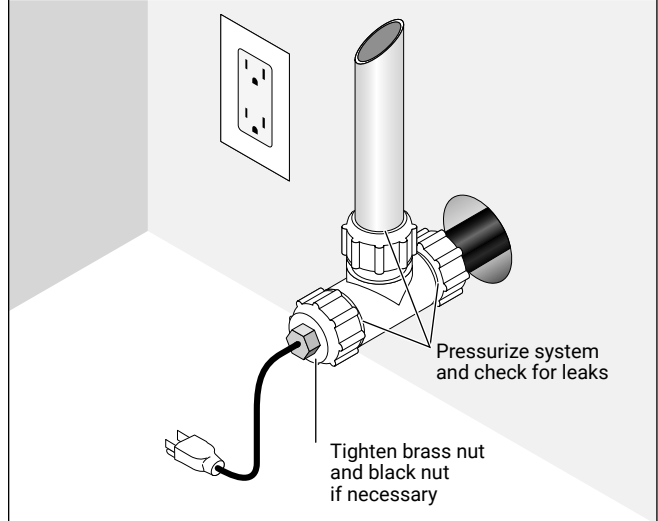

10

- Using 4 screws, mount the temperature controller in a dry location near a 120 volt outlet. Connect the plug from the heating cable to the cord from the temperature controller.
- Attach the temperature sensor to the outdoor section of pipe that is closest to the surface and within the maximum length of the sensor lead wire (it may be necessary to excavate a section of earth over the pipe or drill a hole through

the wall while avoiding damage to the pipe). Keep the sensor at least 3 ft (1 m) away from the outside wall. Tape the sensor lead wire to the pipe at 1 ft (30 cm) intervals. If it is necessary to lengthen the sensor lead wire, contact nVent for recommendations.

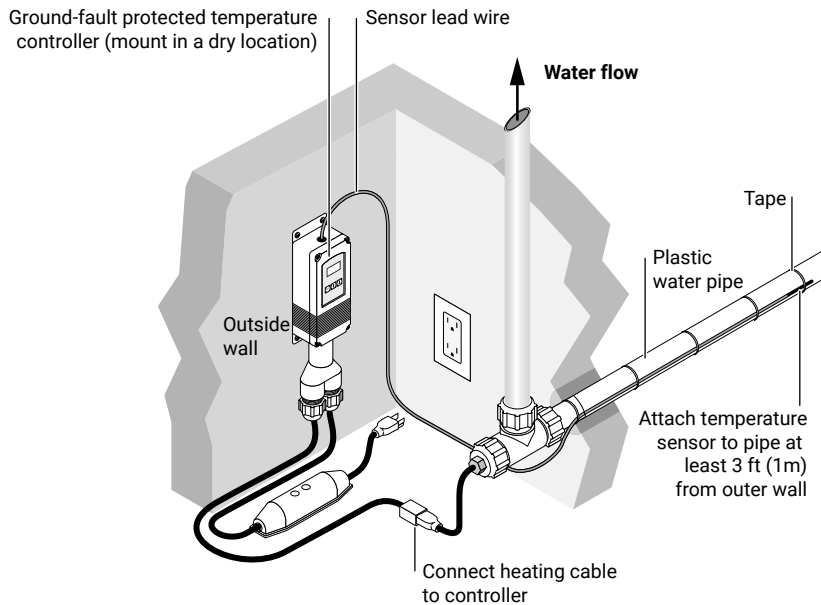

11

- If the water pipe is not already buried, protect the pipe from the wind by burying it at least 3 in (7.5 cm) deep or covering it with earth as shown. On rocky surfaces and where the water pipe enters a lake or river, slide a larger plastic

pipe sleeve (such as 4 in (10 cm) corrugated pipe), over the exposed water pipe to protect from the wind and abrasion damage. Place the far end of the pipe in the lake or river using weights to hold the pipe down as necessary.

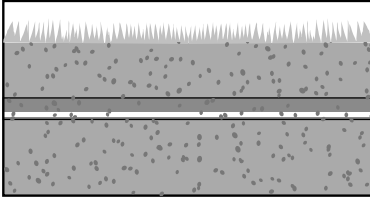

Bury the pipe a minimum of 3 in (7.5 cm) deep

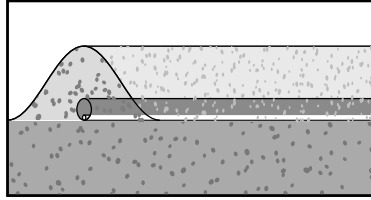

Running above ground, cover with 3 in (7.5 cm) of soil or sand

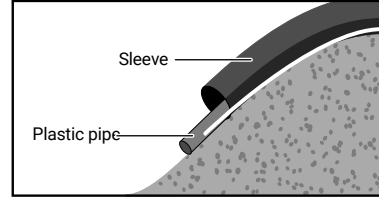

On rocky or inclined surfaces and where the pipe enters the lake, protect with oversized plastic pipe 4 in (10 cm) diameter or larger

12

- Ensure that the pipe is filled with water and plug the temperature controller power cord into a 120 V, 15 A protected outlet. **Note: Do not plug in the power cord if the pipe is empty as this could cause overheating and damage to the pipe.** Check the ground-fault protection device by pressing the “Test” then “Reset” buttons. Check controller settings. If not set to Factory Settings, set the controller following the instructions provided (see next page).

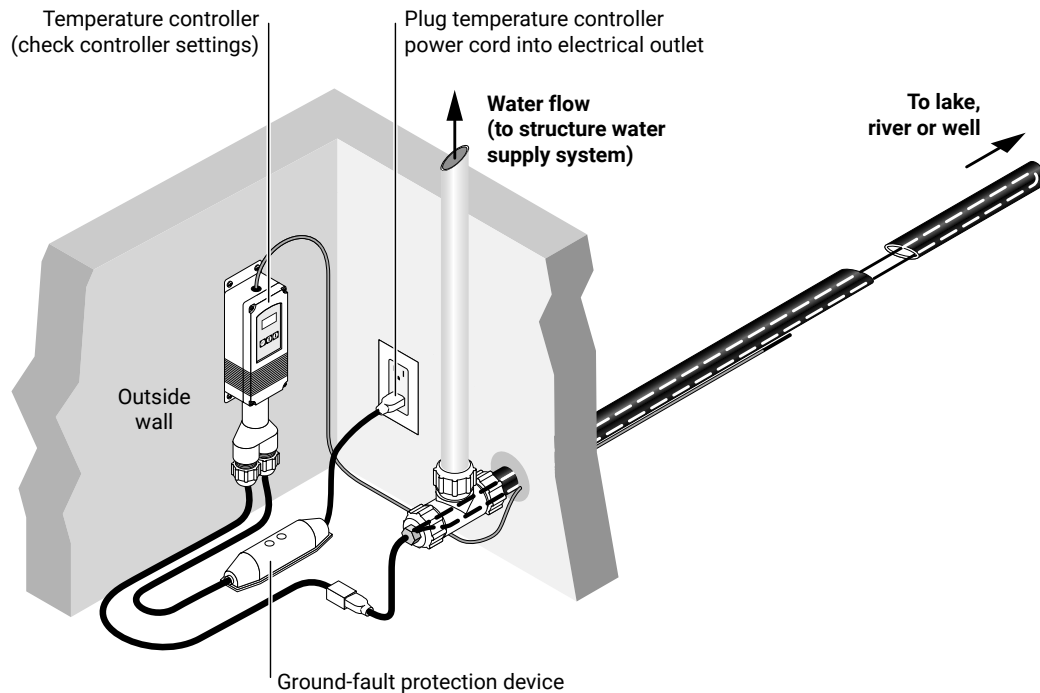

## Programming the Temperature Controller

### Factory settings:

Factory default settings are in °C. The equivalent Fahrenheit settings are shown in parentheses.



Temperature setting:	°C (°F)
Setpoint:	6°C (43°F)
Differential:	2°C (4°F)
Mode:	H1

**Note:** Differential is the number of degrees below the setpoint temperature that the pipe temperature will decrease before the controller energizes the heating cable.

Follow procedure below to change the factory setting.



### Setting the Temperature Controller:

Start programming by pressing 

- (a) Use the  or  arrows to select preferred temperature setting (°F or °C)

 (Example °F)

- (b) Press 

- (a) Use the  or  arrows to select the setpoint ("S1" blinking)



 (Example: 43°F) **Note:** Do not select a setpoint lower than 43°F (6°C).

- (b) Press 

- (a) Use the  or  arrows to set differential ("DIF1" blinking)

 (Example: 4°F) **Note:** Do not select a differential higher than 4°F (2°C).  
**Note:** Differential is the number of degrees below the setpoint temperature that the pipe temperature will decrease before the controller energizes the heating cable.

- (b) Press 

- (a) Use the  or  arrows and select "H1" (For Heating Mode)

 **Note:** Select "H1" heating mode only.  
Do not select "C1" cooling mode - your pipe will freeze.

- (b) Press 

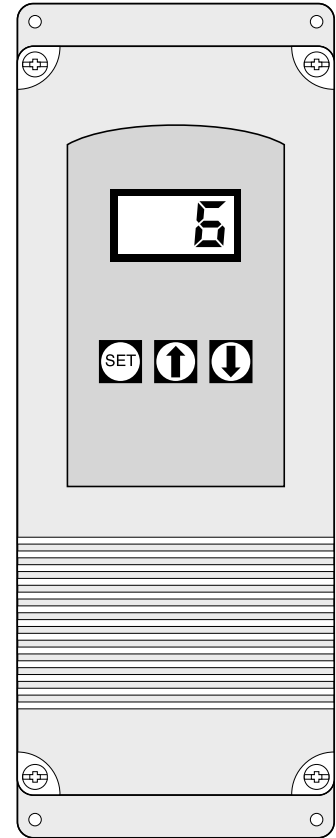

## Temperature Controller Error Codes

- E1** Appears when either the up or down arrow key is pressed when not in programming mode.  
**To correct:** If the E1 message appears even when no keys are being pressed, replace the controller.
- 
- E2** Appears if the control settings are not properly stored in memory.  
**To correct:** Enter programming mode, check all settings and correct if necessary.
- 
- EP** Appears if the temperature sensor is defective or sensing a temperature that is out of range.  
**To correct:** Check if the sensed temperature is out of range - temperature lower than -30°F (-34°) or higher than 220°F (105°C). If not, replace the controller.
- 
- EE** Appears if the controller memory is corrupted.  
**To correct:** Replace the controller.
- 
- CL** Appears if calibration mode has been entered.  
**To correct:** Remove power to the control for at least five seconds. Reapply power. If the CL message still appears, replace the controller.
-

## Replacement Parts

Part Number	Description
PMSFTEE	Blue Tee with 3 black nuts
PMSFADPT1	1 inch fitting kit includes (1) pipe insert with large O-ring, (1) red flange, and (1) black nut reducer
PMSFADPT114	1-1/4 inch fitting kit includes (1) pipe insert with large O-ring, (1) red flange
PMSFPLUG78	Black plastic heating cable insert with O-ring
WPPORING	O-ring for brass nut
MVGFISTAT	Replacement temperature controller with built-in ground-fault protection for 120 V kit
WGNUT	Brass nut for 120 V kit

## Troubleshooting

Problem	Solution
The Tee will not fit properly with my pipe.	<ol style="list-style-type: none"><li>1. Check that it is the correct type of pipe. The blue tee adaptor supplied with the heating cable kit is designed to be used only with the pipe types shown on the first page of this installation instruction.</li><li>2. Check that fittings are in the correct order and facing the proper direction (see Step 2).</li></ol>
The Tee is leaking.	<ol style="list-style-type: none"><li>1. Ensure that the three large plastic nuts are properly tightened.</li><li>2. Check that it is the correct type of pipe. The blue tee adaptor supplied with the heating cable kit is designed to be used only with the pipe types shown on the first page of this installation instruction.</li><li>3. Check that fittings are in the correct order and facing the proper direction (see Step 2).</li><li>4. Ensure that the brass nut on the heating cable entering the blue tee is properly tightened (see Step 9). If the brass nut is over-tightened, the O-ring may have been damaged and may need to be replaced.</li></ol>
Ground-fault protection keeps tripping (red light off when tripped).	<ol style="list-style-type: none"><li>1. Reset ground-fault protection. If ground-fault protection continues to trip, record the serial number from the metal tag attached to the heating cable and call nVent technical support for assistance.</li></ol>
My Tee is cracked or broken.	<ol style="list-style-type: none"><li>1. See <b>Replacement Parts</b>.</li></ol>
My electrical outlet is too far away.	<ol style="list-style-type: none"><li>1. Contact a qualified electrician to install an outlet close to the heating cable kit. Do not use an extension cord with this heating cable kit.</li></ol>
The temperature controller shows a colder temperature than the setpoint temperature.	<ol style="list-style-type: none"><li>1. Check that temperature controller is set to "H1" mode and not "C1" mode.</li><li>2. Check the temperature differential is set correctly (refer to temperature controller programming instructions). This number must not be set higher than 4°F (2°C).</li></ol>
My temperature controller setpoint temperature is 43°F and the differential is 15°F. Why did my pipe freeze?	<ol style="list-style-type: none"><li>1. Differential is the number of degrees below the setpoint temperature that the pipe temperature will decrease before the temperature controller energizes the heating cable. With the differential set to 15°F, the pipe/water temperature will decrease to 28°F (below 32°F freezing point of water, allowing the water in the pipe to freeze), before the heating cable is energized. Change the differential as shown in the programming instructions to fix the problem.</li></ol>
My temperature controller display is blank.	<ol style="list-style-type: none"><li>1. Ground-fault protection has tripped. Reset ground-fault protection. If ground-fault protection continues to trip, record the serial number from the metal tag attached to the heating cable and call nVent technical support for assistance.</li></ol>

## In-Pipe Retro Warranty Information

nVent warrants all In-Pipe Heating Cables against faulty workmanship and use of defective materials for two (2) years from the date of purchase. This warranty can be amended only by a written instrument signed by a duly authorized officer of nVent. Buyer's exclusive remedy under this warranty shall be to have nVent, within a reasonable time, repair such goods or supply replacement goods or credit Buyer's account for such goods and accept their return whichever nVent may elect at its sole discretion. nVent shall in no event be liable for the cost of removal or installation, for loss or damage to or loss of use of facilities or other property, loss of revenue, loss of use of revenue, loss of anticipated profits, or other damages or costs of any kind whatsoever, whether direct, indirect, incidental, or consequential.

Notwithstanding the foregoing, nVent shall have no liability whatsoever unless: (a) Buyer promptly notifies nVent in writing after discovery of an alleged nonconformity and includes a detailed explanation of the alleged nonconformity; (b) buyer promptly returns goods to nVent postage prepaid, at 250 West Street, Trenton, Ontario, K8V 5S2, Canada; and (c) nVent examination of such goods establishes to nVent satisfaction that

such alleged nonconformities actually exist and occurred in the cause of proper and normal use and were not caused by accident, misuse, neglect, alteration or improper installation, repair or testing or such other cause outside of the responsibility of nVent under this Limited Warranty. **THE FOREGOING WARRANTY IS IN LIEU OF ALL OTHER REPRESENTATIONS, WARRANTIES, OR CONDITIONS, EXPRESS OR IMPLIED, INCLUDING WITHOUT LIMITATION ANY IMPLIED WARRANTY OF MERCHANTABILITY, FITNESS FOR A PARTICULAR PURPOSE OR NONINFRINGEMENT, AND OF ANY OTHER OBLIGATION OR LIABILITY ON THE PART OF NVENT, WHETHER BY STATUTE, CONTRACT, STRICT LIABILITY, TORT OR OTHERWISE.** If the goods are a consumer product in buyer's jurisdiction, the above exclusion or limitation of incidental or consequential damages and the above disclaimer of implied warranties may not apply. The term of any such implied warranty is limited to the term of this two-year Limited Warranty. Some jurisdictions do not allow limitations on how long an implied warranty lasts, so the above limitation may not apply. This warranty gives consumers specific legal rights, and consumers may also have other rights, which vary by jurisdiction.

### North America

Tel +1.800.545.6258  
Fax +1.800.527.5703  
thermal.info@nvent.com

### Europe, Middle East, Africa

Tel +32.16.213.511  
Fax +32.16.213.604  
thermal.info@nvent.com

### Asia Pacific

Tel +86.21.2412.1688  
Fax +86.21.5426.3167  
cn.thermal.info@nvent.com

### Latin America

Tel +1.713.868.4800  
Fax +1.713.868.2333  
thermal.info@nvent.com



[nVent.com](http://nVent.com)

© 2018 nVent. All nVent marks and logos are owned or licensed by nVent Services GmbH or its affiliates. All other trademarks are the property of their respective owners. nVent reserves the right to change specifications without notice.

Raychem-IM-H56925-InPipeRetro120V-EN-1811 INSTR12